



WarmlyYours

Be Connected.
Be Warm. Be Radiant.

PRODUCT CATALOG



Floor Heating Collection



About WarmlyYours Heating

Frequently, we are asked how we chose the name of our company. When we began as an electric radiant heating products business over 25 years ago, we wanted a name that would embody the very essence of our business philosophy – treat our customers well and offer the very best floor-warming systems and services in the industry. And above all else, always deliver on those promises to our customers.

The name WarmlyYours reflects our deep, personal commitment to providing our customers with the exceptional customer service that they deserve. We welcome any questions and relish the opportunity to provide our customers with prompt and friendly assistance. Listening to feedback from thousands of homeowners and installers, we continue to improve on everything we do in our effort to better serve our customers. As a result, we have expanded our portfolio to include other radiant heating products – such as towel warmers and radiant panels – to bring comfort and affordable luxury to all areas of the home.

WarmlyYours has locations in the United States, Canada, and Europe. All of our customers recognize our commitment to exceptional service and product quality.

99% ★★★★★
of our customers report complete satisfaction with our service

97% ★★★★★
of our customers report complete confidence in our product quality



Radiantly Yours

At WarmlyYours, we are proud to offer a radiant solution for every area of life. From our flagship product, our electric floor heating systems, to our outdoor snow melting and deicing options, our award-winning radiant heating panels and complete electric towel warmer collection, we are confident that you will find every need more than matched by our range of high-quality products.

Each product is designed to install easily and includes 24/7 technical support, saving you time and money. Your dedicated account manager is there to support you with a quotation and custom installation plan within 24 hours, and we'll ship your order the very same day you place it. We promise you that our focus on customer service beats any other company in the industry.

Julia Billen – President & Owner

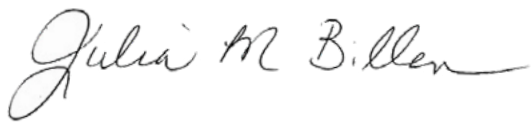

WarmlyYours Advantage

WarmlyYours, with operations around the world, still strives to focus on the details that have turned the company into the industry leading force that it is today: high-quality products and unparalleled customer service.

Over the years, our product offering has expanded but we have never lost focus on making sure these products are durable and functional enough to maintain our standards.

Similarly, we've expanded our customer service offerings by providing 24/7 technical support, free design services, and our SmartServices for installation, in-field troubleshooting, and more.

Start Out Right...

With our trusted experience in producing high-quality, innovative radiant heat products, we not only make comfort attainable, but we make the whole experience easy for you to provide radiant warmth for your clients.

Expansive Product Portfolio

WarmlyYours has a heating system for nearly every floor-type—from tile to nailed hardwood and everything in-between. Our team of Radiant Experts will make sure that you find the perfect heating system for your project.

www.warmlyyours.com/floor-heating

Heat Loss Calculator

Can electric floor heating be the primary heat source in your project? Now it's easier than ever to find out the answer with the WarmlyYours Heat Loss Calculator. With just a few details about your project, this free online tool will estimate how much heat is being lost in a room and if electric floor heating can be the primary heat source.

www.warmlyyours.com/floor-heating/heatloss-calculator

Operating Cost Calculator

Input the size of the area that you would like to heat, along with the cost of the kWh in your state, and we'll tell you how much it will cost to heat the room or area, so that you can easily and accurately provide this information to your client.

www.warmlyyours.com/floor-heating/cost-calculator

Same Day Shipping

For Canadian orders shipping via parcel, simply submit your order by these times and we will process your order and have it on its way by the end of the day:

2:30 PM Eastern Time for UPS, Purolator and Canpar

12 PM Eastern Time for Canada Post

9 AM Eastern Time for Freight



Finish Strong...

Our No Nonsense™ Warranty is renowned for being an industry best: we will cover not only the cost of labor, but also the cost of the floor itself.

Industry Leading 24/7 Installation Support

We're here for you. Call us anytime – day or night, weekday or weekend – with any questions or installation challenges. That's our commitment to you and your business. www.warmlyyours.com/services/troubleshooting

WarmlyYours No Nonsense™ Warranty

WarmlyYours No Nonsense™ Warranty is the most comprehensive warranty in the industry. We guarantee our indoor floor heating elements to be free from defects in material and workmanship for 25 (TempZone™) and 5-10 (Environ™) years from the date of purchase. Because we don't prorate your coverage, you have the same coverage over the entire life of the warranty. Unlike other companies, WarmlyYours will cover the cost of the warming roll AND the floor covering material AND labor in the event of a defect.

www.warmlyyours.com/contact/warranty-floor-heating

No Restocking Fees

At WarmlyYours, we do not have restocking fees for any of our products.

Open Return Policy

Our open return policy is simple—there are no time limits. If we still sell the product and it's in resalable condition, you may return it at any time—even years later.

We know that life doesn't always run according to an ideal schedule, and at WarmlyYours, you come first.

The WarmlyYours SmartPlan™

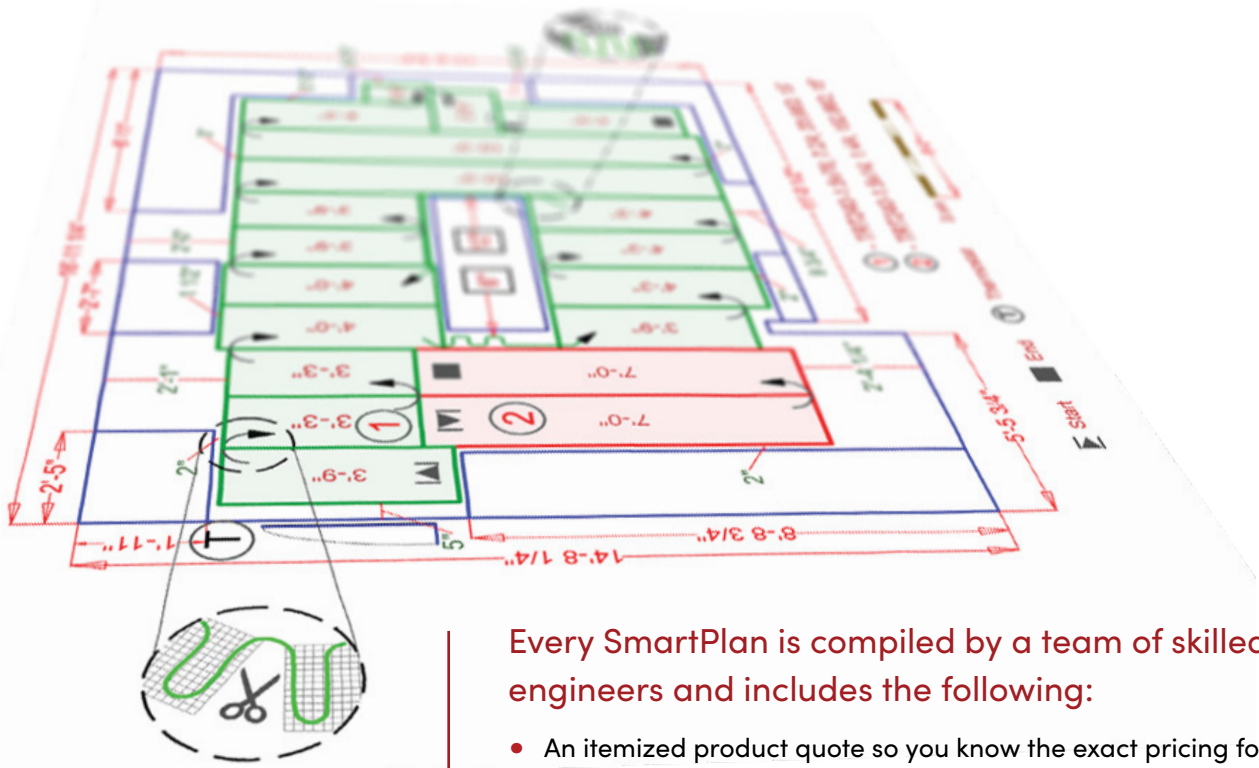

Life is easier when you have a plan.

WarmlyYours has condensed decades of radiant heating experience into our **FREE**, no obligation SmartPlans™. When you're installing a floor heating system, a WarmlyYours SmartPlan™ makes sure your project starts off right and finishes strong.

Every SmartPlan is compiled by a team of skilled engineers and includes the following:

- An itemized product quote so you know the exact pricing for your project
- An electrical plan that tells you exactly what's needed to get your system up and running
- An installation plan that gives detailed information to cut down on time and effort

All you have to do to take advantage of this service is to provide WarmlyYours with a simple floor plan sketch, and you'll receive your SmartPlan™, typically within 24 hours. Anyone can draw a floor plan sketch—it doesn't have to be fancy, it just has to show the room's dimensions and note any permanent fixtures like tubs, cabinets, or air-vents.

You can send your floor plan sketch to WarmlyYours by:

- Drawing or uploading it directly to the WarmlyYours Radiant Floor Heating Quote Builder
- Faxing it to us at (800) 408-1100
- Scanning or taking a photo and emailing the file to us at info@WarmlyYours.com

The Radiant Floor Heating Quote Builder

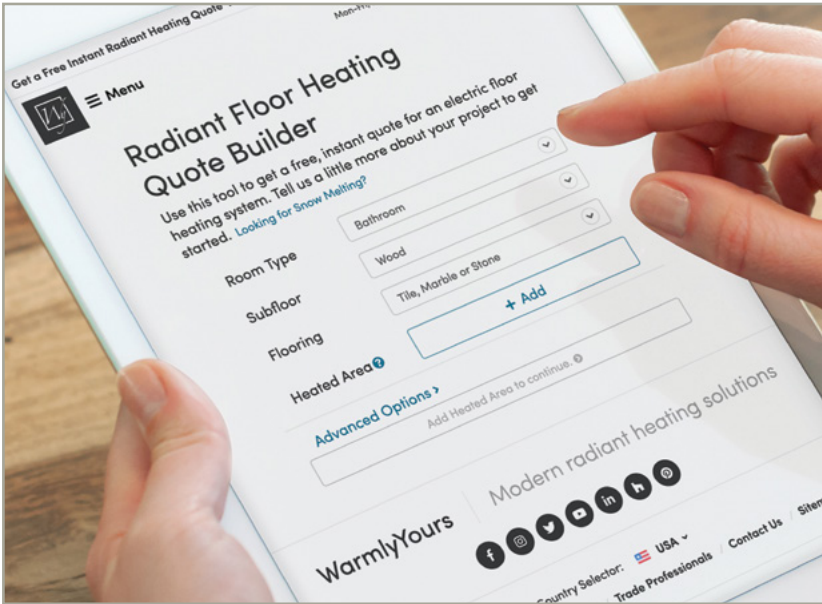

WarmlyYours has always been at the forefront of radiant heating technology. We were the first company to develop an online quotation tool for radiant heating products because we had both the expertise and the drive to empower our customers during the buying process.

Our Radiant Floor Heating Quote Builder represents the culmination of decades of experience and know-how that has been condensed into an easy-to-use option for getting free and instant floor heating quotes online.

By simply providing a few project details, you'll be presented with a side-by-side comparison, complete with pricing and product information, of the heating systems that will work with your project.

From there, you can purchase the system directly or get a free SmartPlan™ installation plan by either uploading a project sketch or by using our online Design Tool.

Check it out for yourself by going to www.warmlyyours.com/quote

The WarmlyYours Design Tool

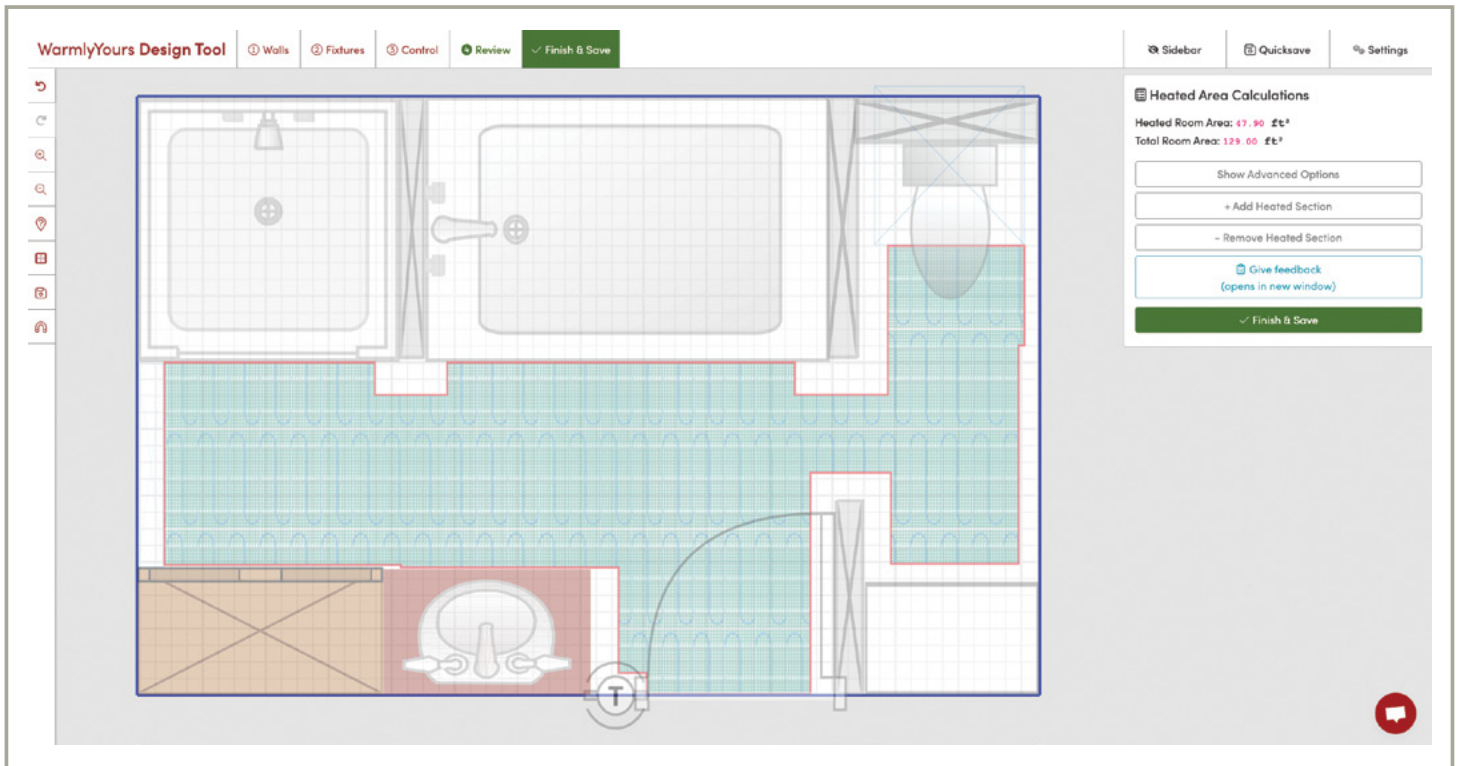

Our Design Tool is the only one of its kind in the industry. Not everyone is comfortable drawing a floor plan or project sketch but with our tool you can take out the guesswork. In just a few clicks, you can "draw" your project to scale and add a variety of different fixtures and furnishings.

The Design Tool is a part of our Quote Builder. Once you've created your room, you can then save it to your quote in the Quote Builder. From there, you'll be able to build your floor heating system based on your drawing or you can request a custom SmartPlan™ installation plan from our team of skilled engineers.

Then you can also use the "Share this quote" function to generate a unique URL that will allow you to send your project to anyone.

Features of the Design Tool:

- Allows you to create a digital version of your project in real time
- Intuitive menu-based and drag-and-drop controls throughout the tool
- A variety of pre-loaded room shapes are available for you to choose from
- Can be saved to your quote and shared via a generated URL
- A wide range of fixtures and furnishings can be added to your room for extra accuracy



Only available to new and existing professional WarmlyYours customers.

Speak to your account manager for information about ordering along with pro and volume discounts.

TempZone™ Floor Heating Ruler Cable

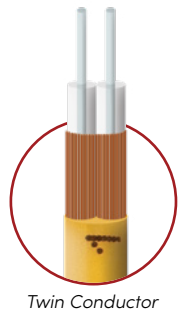

Twin Conductor

The TempZone Floor Heating Ruler Cable is the first electric radiant heating cable to feature easy-to-read hash marks at every half-inch, inch, and foot increment. This innovative design ensures the installer is using the proper amount of cable while they're laying it out for a smooth installation and even heating for the end user.

The TempZone Floor Heating Ruler Cable can be installed in two different ways: with GripStrip™ fixing strips or with an uncoupling membrane like the Prodeso Membrane. The GripStrips are complimentary and are the most economical option for installation. Using an uncoupling membrane provides benefits like speed of installation and crack isolation.

- Comes with easy-to-read hash marks at every half-inch, inch, and foot increment on the cable
- Due to its structure and composition, this cable is extremely flexible and durable
- Can be installed with either GripStrip fixing strips or the Prodeso Membrane
- Installation with the membrane is faster and provides uncoupling benefits
- Installation with fixing strips is more economical and provides more design flexibility
- Can be geo-targeted to your locale during the design process to ensure optimal efficiency and lowest possible operating cost
- The energy efficient twin-conductor cable outputs 3.7-watts per linear foot
- Heat output of between 9 to 15-watts/sq. ft., depending on spacing
- Covered by our unbeatable 25-year No Nonsense™ Warranty
- Wet Location and UL Listed

For Tile, Marble, Stone, or
Luxury Vinyl Floors



TempZone™ Floor Heating Ruler Cable and GripStrips

SmartPlan™

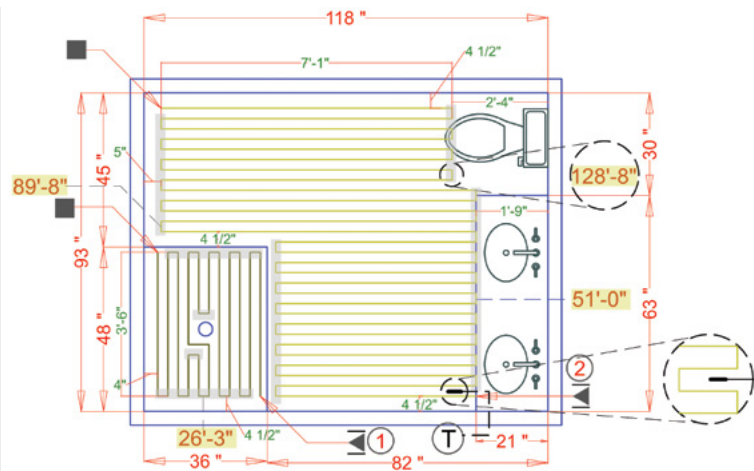

RCT-120-0040 and RCT-120-0180 shown above

120 Volt TempZone™ Floor Heating Ruler Cables

SKU	Cable Length in Feet	Coverage in Sq. Ft.				WATTS	AMPS	MSRP
		3" Spacing	3.75" Spacing	4" Spacing (Recommended)	5" Spacing			
		GripStrips	Prodeso Membrane	GripStrips	Both Strips and Membrane			
RCT-120-0030	30	7.5	9.3	9.9	12.5	111	1.0	\$169
RCT-120-0040	40	10.0	12.5	13.3	16.6	148	1.3	\$209
RCT-120-0050	50	12.5	15.6	16.6	20.8	185	1.6	\$239
RCT-120-0070	70	17.5	21.8	23.3	29.1	259	2.2	\$289
RCT-120-0090	90	22.5	28.1	29.9	37.5	333	2.8	\$349
RCT-120-0120	120	30.0	37.5	39.9	50.0	444	3.7	\$409
RCT-120-0150	150	37.5	46.8	49.9	62.5	555	4.7	\$479
RCT-120-0180	180	45.0	56.2	59.9	75.0	666	5.6	\$539
RCT-120-0220	220	55.0	68.7	73.3	91.6	814	6.8	\$609
RCT-120-0260	260	65.0	81.2	86.6	108.3	962	8.1	\$669
RCT-120-0300	300	75.0	93.7	99.9	125.0	1,110	9.3	\$729
RCT-120-0340	340	85.0	106.2	113.3	141.6	1,258	10.5	\$779
RCT-120-0375	375	93.7	117.1	124.9	156.2	1,388	11.6	\$829
RCT-120-0432	432	108.0	135.0	143.9	180.0	1,598	13.4	\$929

240 Volt TempZone™ Floor Heating Ruler Cables

SKU	Cable Length in Feet	Coverage in Sq. Ft.				WATTS	AMPS	MSRP
		3" Spacing	3.75" Spacing	4" Spacing (Recommended)	5" Spacing			
		GripStrips	Prodeso Membrane	GripStrips	Both Strips and Membrane			
RCT-240-0055	55	13.7	17.1	18.3	22.9	204	0.9	\$249
RCT-240-0065	65	16.2	20.3	21.6	27.0	241	1.1	\$279
RCT-240-0075	75	18.7	23.4	24.9	31.2	278	1.2	\$299
RCT-240-0095	95	23.7	29.6	31.6	39.5	352	1.5	\$359
RCT-240-0115	115	28.7	35.9	38.3	47.9	426	1.8	\$399
RCT-240-0155	155	38.7	48.4	51.6	64.5	574	2.4	\$489
RCT-240-0195	195	48.7	60.9	64.9	81.2	722	3.1	\$569
RCT-240-0235	235	58.7	73.4	78.3	97.9	870	3.7	\$639
RCT-240-0275	275	68.7	85.9	91.6	114.5	1,018	4.3	\$699
RCT-240-0315	315	78.7	98.4	104.9	131.2	1,166	4.9	\$749
RCT-240-0355	355	88.7	110.9	118.3	147.9	1,314	5.5	\$799
RCT-240-0395	395	98.7	123.4	131.6	164.5	1,462	6.1	\$859
RCT-240-0435	435	108.7	135.9	144.9	181.2	1,610	6.8	\$929
RCT-240-0515	515	128.7	160.9	171.6	214.6	1,906	8.0	\$1,039
RCT-240-0595	595	148.7	185.9	198.3	247.9	2,202	9.2	\$1,159
RCT-240-0675	675	168.7	210.9	224.9	281.2	2,498	10.5	\$1,279
RCT-240-0749	749	187.2	234.0	249.6	312.1	2,771	11.6	\$1,389
RCT-240-0864	864	216.0	270.0	287.9	360.0	3,197	13.4	\$1,509

TempZone™ Flex Rolls

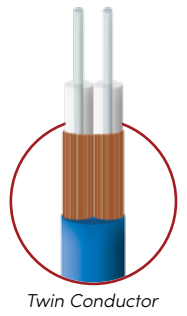

TempZone™ Flex Rolls were designed to provide full coverage heating while making installation as easy and straight forward as possible.

These twin-conductor rolls can be installed using the expedient “cut-and-turn” method which is perfect for traditional room shapes.

The evenly spaced, 3” serpentine loop design delivers more heating capacity and faster floor warm-ups than most competitive systems.

At less than 1/8” thick, TempZone™ Flex Rolls install easily under tile, stone, marble or LVT flooring without significantly increasing floor height.

For Tile, Marble, Stone, or
Luxury Vinyl Floors

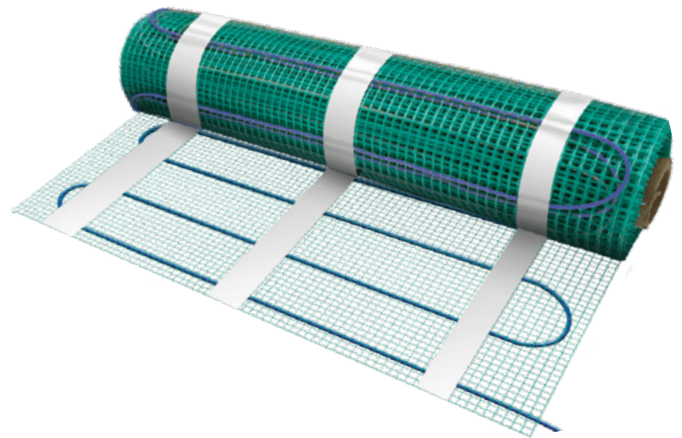

TempZone™ Flex Roll

- Our most popular floor heating product
- Its cut-and-turn installation method is fast and easy
- Provides a heat output of 15-watts per sq. ft.
- Only 1/8” thick, so minimal impact on floor height
- Uses an energy efficient, twin conductor heating cable
- Covered by our unbeatable 25-year No Nonsense™ Warranty
- Wet Location and UL Listed
- Circuit Check available to ensure fault-free installation

SmartPlan™

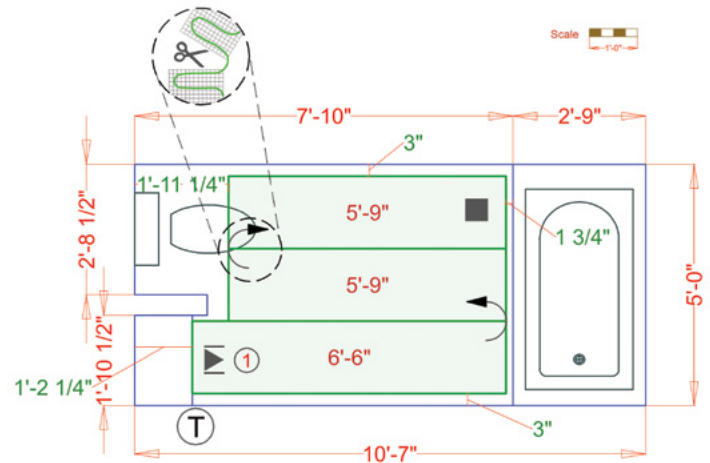

TRT120-1.5X18 shown above

120 Volt TempZone™ Flex Rolls

SKU	DIMENSIONS	SQ. FT.	WATTS	AMPS	MSRP
TRT120-1.5x04	1.5' x 4'	6.0	90	0.80	\$179
TRT120-1.5x06	1.5' x 6'	9.0	135	1.20	\$249
TRT120-1.5x09	1.5' x 9'	13.5	203	1.70	\$359
TRT120-1.5x12	1.5' x 12'	18.0	270	2.30	\$459
TRT120-1.5x15	1.5' x 15'	22.5	338	2.90	\$489
TRT120-1.5x18	1.5' x 18'	27.0	405	3.40	\$549
TRT120-1.5x21	1.5' x 21'	31.5	473	4.00	\$599
TRT120-1.5x24	1.5' x 24'	36.0	540	4.50	\$649
TRT120-1.5x27	1.5' x 27'	40.5	608	5.10	\$729
TRT120-1.5x30	1.5' x 30'	45.0	675	5.70	\$779
TRT120-1.5x33	1.5' x 33'	49.5	743	6.20	\$819
TRT120-1.5x38	1.5' x 38'	57.0	855	7.20	\$899
TRT120-1.5x43	1.5' x 43'	64.5	968	8.10	\$969
TRT120-1.5x48	1.5' x 48'	72.0	1,080	9.00	\$1,079
TRT120-1.5x52	1.5' x 52'	78.0	1,170	9.80	\$1,119
TRT120-1.5x56	1.5' x 56'	84.0	1,260	10.50	\$1,199
TRT120-1.5x60	1.5' x 60'	90.0	1,350	11.25	\$1,289
TRT120-1.5x66	1.5' x 66'	99.0	1,485	12.38	\$1,409
TRT120-1.5x70	1.5' x 70'	105.0	1,575	13.13	\$1,419

240 Volt TempZone™ Flex Rolls

SKU	DIMENSIONS	SQ. FT.	WATTS	AMPS	MSRP
TRT240-1.5x8	1.5' x 8'	12.0	180	0.80	\$319
TRT240-1.5x14	1.5' x 14'	21.0	315	1.40	\$499
TRT240-1.5x17	1.5' x 17'	25.5	383	1.60	\$549
TRT240-1.5x22	1.5' x 22'	33.0	495	2.10	\$599
TRT240-1.5x29	1.5' x 29'	43.5	653	2.80	\$759
TRT240-1.5x36	1.5' x 36'	54.0	810	3.40	\$909
TRT240-1.5x42	1.5' x 42'	63.0	945	4.00	\$959
TRT240-1.5x46	1.5' x 46'	69.0	1,035	4.40	\$1,049
TRT240-1.5x49	1.5' x 49'	73.5	1,103	4.60	\$1,119
TRT240-1.5x54	1.5' x 54'	81.0	1,215	5.10	\$1,169
TRT240-1.5x57	1.5' x 57'	85.5	1,283	5.35	\$1,239
TRT240-1.5x66	1.5' x 66'	99.0	1,485	6.20	\$1,429
TRT240-1.5x76	1.5' x 76'	114.0	1,710	7.20	\$1,559
TRT240-3.0x43	3.0' x 43'	129.0	1,935	8.10	\$1,759
TRT240-3.0x48	3.0' x 48'	144.0	2,160	9.00	\$1,859
TRT240-3.0x52	3.0' x 52'	156.0	2,340	9.80	\$2,009
TRT240-3.0x60	3.0' x 60'	180.0	2,700	11.25	\$2,319
TRT240-3.0x70	3.0' x 70'	210.0	3,150	13.13	\$2,549

Pricing subject to change, because life happens.

Project Showcase

TempZone™ Flex Roll



Kitchen and Dining Nook

Richmond Hill, ON

Room Type	Kitchen
Watts	1,346W
Volts	120V
Amps	11A
Size	132 sq. ft.
Operating Cost Per Hour	\$0.06

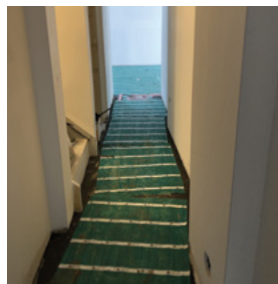
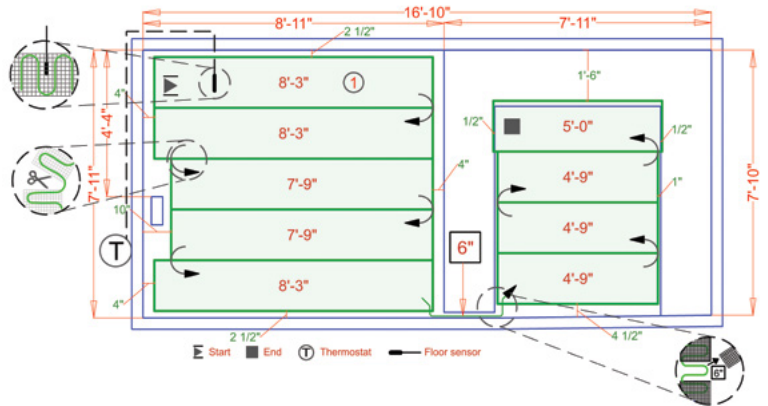

Basement Playroom

Whitchurch-Stouffville, ON

Room Type	Basement
Watts	4,094W
Volts	240V
Amps	17.06A
Size	315 sq. ft.
Operating Cost Per Hour	\$0.19

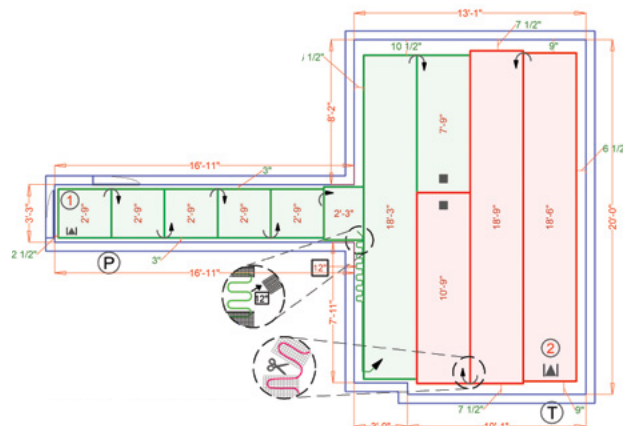
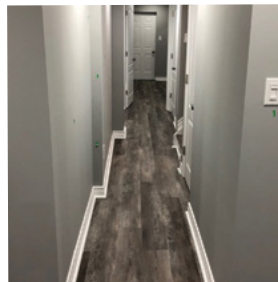

TempZone™ Easy Mats

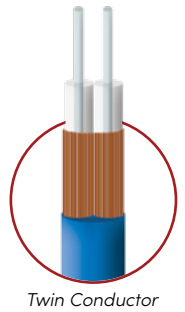

TempZone™ Easy Mats are used to provide targeted “spot heating” in high-traffic areas under tile, stone, marble or LVT flooring.

Heating only the areas you use most helps to cut down on both material and operating costs without sacrificing comfort.

These twin-conductor mats are easy to install as they require no cutting— simply unroll it, attach it onto the subfloor, embed it in adhesive (thinset or self-leveling cement), and finally install the floor covering. Popular locations for TempZone™ Easy Mats are often bathrooms, kitchens, and foyers.

For Tile, Marble, Stone, or
Luxury Vinyl Floors

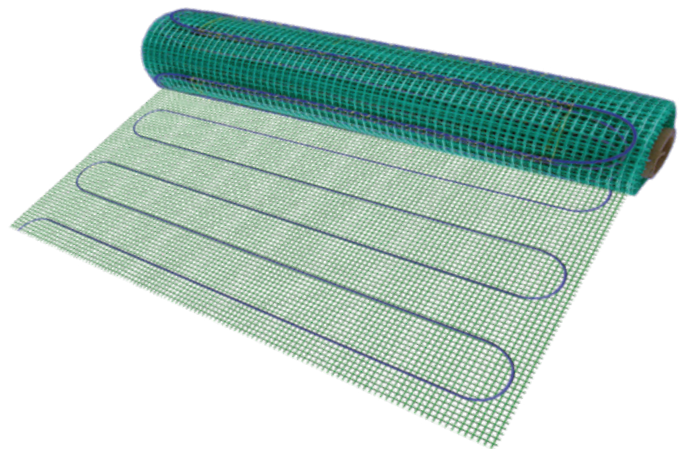

TempZone™ Easy Mat

- Excellent option for targeted spot-heating
- Easy set-and-go installation method
- Heat output of 15-watts per sq. ft.
- 1/8” thickness won’t significantly increase floor height
- The heating cable is twin conductor and energy efficient
- Covered by our unbeatable 25-year No Nonsense™ Warranty
- Wet Location and UL Listed
- Circuit Check available to ensure fault-free installation

SmartPlan™

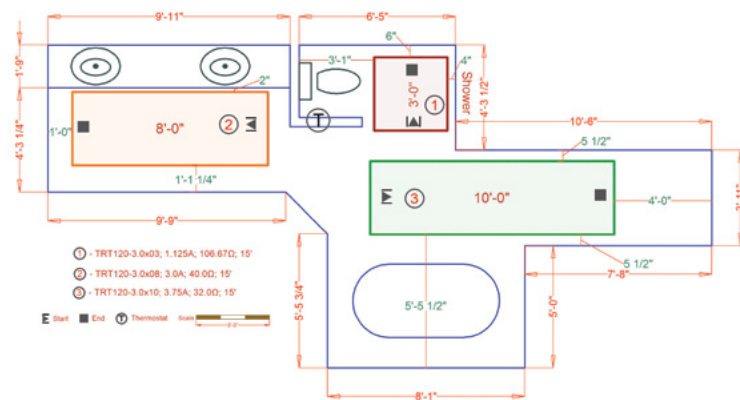

TRT120-3x3, TRT120-3X8 and TRT120-3X10 shown above

Spot heating is the use of an electric floor warming mat to only heat a specific area. This targeted heating method is extremely cost effective as it cuts down on installation time, material costs, and recurring operation costs—all while providing a high degree of comfort and luxury for the homeowner.

TempZone™ Easy Mats have been purpose-built for this type of heating and are a great option for rooms where foot traffic will be largely limited to a specific space.

120 Volt TempZone™ Easy Mat					
SKU	DIMENSIONS	SQ. FT.	WATTS	AMPS	MSRP
TRT120-3.0x02	3' x 2'	6	90	0.75	\$179
TRT120-3.0x03	3' x 3'	9	135	1.13	\$209
TRT120-3.0x05	3' x 5'	15	225	1.88	\$249
TRT120-3.0x06	3' x 6'	18	270	2.25	\$359
TRT120-3.0x08	3' x 8'	24	360	3.00	\$419
TRT120-3.0x10	3' x 10'	30	450	3.75	\$449

Pricing subject to change, because life happens.

TempZone™ Floor Heating Cable

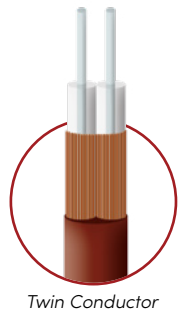

TempZone™ Floor Heating Cable brings radiant warmth and comfort to any room.

This free-form cable provides the ultimate in flexibility, making it easy to customize installation for rooms of any size and shape.

The cable can be installed with either Fixing Strips or the Prodeso Cable Installation Membrane. The Fixing Strips are more economical but also more labor intensive while the membrane provides long-lasting uncoupling benefits for tile or stone floors.

- Can be installed with either fixing strips or the Prodeso Membrane
- Installation with the membrane is faster and provides uncoupling benefits
- Installation with fixing strips is more economical and provides more design flexibility
- Can be geo-targeted to your locale during the design process to ensure optimal efficiency and lowest possible operating cost
- The energy efficient cable outputs 3.7-watts per linear foot
- Twin conductor cable with a thickness of 3/16"
- Heat output of between 9 to 15-watts/sq. ft., depending on spacing
- Covered by our unbeatable 25-year No Nonsense™ Warranty
- Wet Location and UL Listed
- Circuit Check available to ensure fault-free installation

For Tile, Marble, Stone, or
Luxury Vinyl Floors



TempZone™ Heating Cable

SmartPlan™

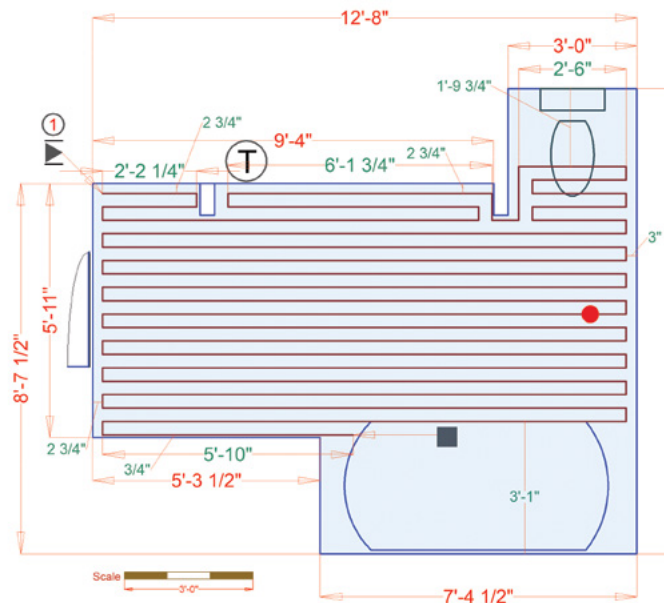

TCT1240-3.7W-235 shown above

120 Volt TempZone™ Floor Heating Cables

SKU	Cable length in feet	Coverage in Sq. Ft.							WATTS	AMPS	MSRP
		3" spacing		3.5" spacing	3.75" spacing	4" spacing		5" spacing			
		Fixing Strips Only	Fixing Strips Needed	Competitor's Membrane	Prodeso Membrane Only	Fixing Strips Only	Fixing Strips Needed	Both Strips and Membrane			
TCT120-3.7W-030	30	7.5	9	8.8	9.3	9.9	12	12.5	111	1.0	\$169
TCT120-3.7W-040	40	10.0	12	11.7	12.5	13.3	12	16.6	148	1.3	\$209
TCT120-3.7W-050	50	12.5	12	14.6	15.6	16.6	20	20.8	185	1.6	\$239
TCT120-3.7W-070	70	17.5	20	20.4	21.8	23.3	20	29.1	259	2.2	\$289
TCT120-3.7W-090	90	22.5	20	26.3	28.1	29.9	24	37.5	333	2.8	\$349
TCT120-3.7W-120	120	30.0	24	35.0	37.5	39.9	35	50.0	444	3.7	\$409
TCT120-3.7W-150	150	37.5	35	43.8	46.8	49.9	40	62.5	555	4.7	\$479
TCT120-3.7W-180	180	45.0	35	52.5	56.2	59.9	48	75.0	666	5.6	\$539
TCT120-3.7W-220	220	55.0	48	64.2	68.7	73.3	54	91.6	814	6.8	\$609
TCT120-3.7W-260	260	65.0	54	75.8	81.2	86.6	70	108.3	962	8.1	\$669
TCT120-3.7W-300	300	75.0	54	87.5	93.7	99.9	77	125.0	1,110	9.3	\$729
TCT120-3.7W-340	340	85.0	70	99.2	106.2	113.3	88	141.6	1,258	10.5	\$779
TCT120-3.7W-375	375	93.7	70	109.4	117.1	124.9	96	156.2	1,388	11.6	\$829
TCT120-3.7W-432	432	108.0	77	126.0	135.0	143.9	104	180.0	1,598	13.4	\$929

240 Volt TempZone™ Floor Heating Cables

SKU	Cable length in feet	Coverage in Sq. Ft.							WATTS	AMPS	MSRP
		3" spacing		3.5" spacing	3.75" spacing	4" spacing		5" spacing			
		Fixing Strips Only	Fixing Strips Needed	Competitor's Membrane	Prodeso Membrane Only	Fixing Strips Only	Fixing Strips Needed	Both Strips and Membrane			
TCT240-3.7W-055	55	13.7	12	16.0	17.1	18.3	20	22.9	204	0.9	\$249
TCT240-3.7W-065	65	16.2	20	19.0	20.3	21.6	20	27.0	241	1.1	\$279
TCT240-3.7W-075	75	18.7	20	21.9	23.4	24.9	24	31.2	278	1.2	\$299
TCT240-3.7W-095	95	23.7	24	27.7	29.6	31.6	30	39.5	352	1.5	\$359
TCT240-3.7W-115	115	28.7	24	33.5	35.9	38.3	35	47.9	426	1.8	\$399
TCT240-3.7W-155	155	38.7	35	45.2	48.4	51.6	48	64.5	574	2.4	\$489
TCT240-3.7W-195	195	48.7	40	56.9	60.9	64.9	54	81.2	722	3.1	\$569
TCT240-3.7W-235	235	58.7	48	68.5	73.4	78.3	70	97.9	870	3.7	\$639
TCT240-3.7W-275	275	68.7	54	80.2	85.9	91.6	70	114.5	1,018	4.3	\$699
TCT240-3.7W-315	315	78.7	70	91.9	98.4	104.9	77	131.2	1,166	4.9	\$749
TCT240-3.7W-355	355	88.7	70	103.5	110.9	118.3	88	147.9	1,314	5.5	\$799
TCT240-3.7W-395	395	98.7	77	115.2	123.4	131.6	96	164.5	1,462	6.1	\$859
TCT240-3.7W-435	435	108.7	77	126.9	135.9	144.9	104	181.2	1,610	6.8	\$929
TCT240-3.7W-515	515	128.7	96	150.2	160.9	171.6	126	214.6	1,906	8.0	\$1,039
TCT240-3.7W-595	595	148.7	117	173.5	185.9	198.3	150	247.9	2,202	9.2	\$1,159
TCT240-3.7W-675	675	168.7	126	196.9	210.9	224.9	160	281.2	2,498	10.5	\$1,279
TCT240-3.7W-749	749	187.2	126	218.5	234.0	249.6	176	312.1	2,771	11.6	\$1,389
TCT240-3.7W-864	864	216.0	150	252.0	270.0	287.9	198	360.0	3,197	13.4	\$1,509

Project Showcase

TempZone™ Cable and Prodeso Coupling Membrane

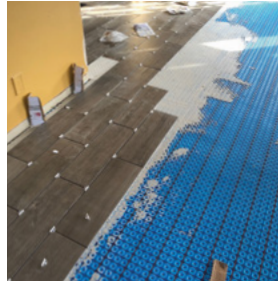

Family Room

📍 Dearborn, MI

Room Type	Family Room
Watts	3,236W
Volts	240V
Amps	13.48A
Size	270 sq. ft.
Operating Cost Per Hour	\$0.14

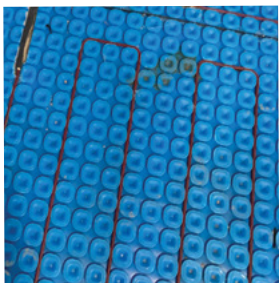
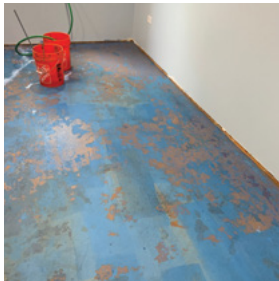
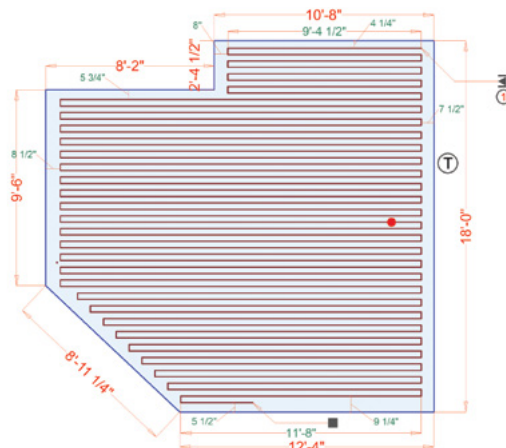

Basement with Prodeso Membrane

📍 Westmont, IL

Room Type	Basement
Watts	4,870W
Volts	240V
Amps	20.29A
Size	473 sq. ft.
Operating Cost Per Hour	\$0.31

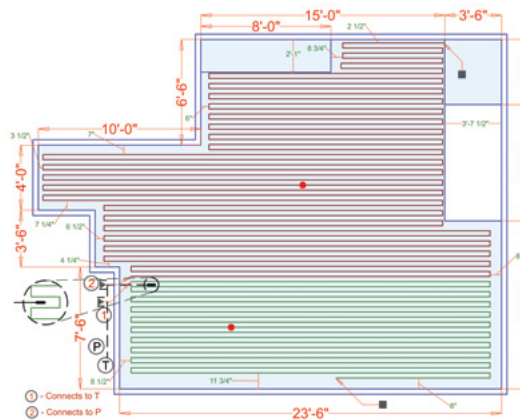

TempZone™

Shower Floor and Bench Mats

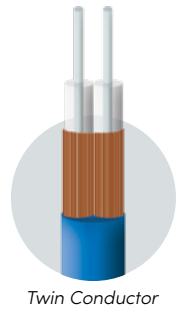

Tiled showers are growing in popularity due to the elegant possibilities that they open for bathroom design projects.

Whether you're installing a traditional tiled shower, a curbless shower, or an entire wet room, radiant heating can help make these beautiful installations feel as good as they look.

Our TempZone™ Shower Mats and Shower Bench Mats are a great option for these applications. Both products are easy to install in either a tiled shower floor or a tiled shower bench.

- Bench Mats are used to warm tiled shower benches
- Shower Mats are used to warm the area around a tiled shower's drain
- Shower Mats come with an integrated drain hole
- Simple installation, no cutting required
- Shower Mats and Bench Mats provide 15-watts per sq. ft.
- Heating element thickness is only 1/8"
- Covered by our unbeatable 25-year No Nonsense™ Warranty
- Wet Location and UL Listed
- Circuit Check available to ensure fault-free installation

For Tile, Marble or Stone



TempZone™ Shower Floor and Bench Mats

SmartPlan™

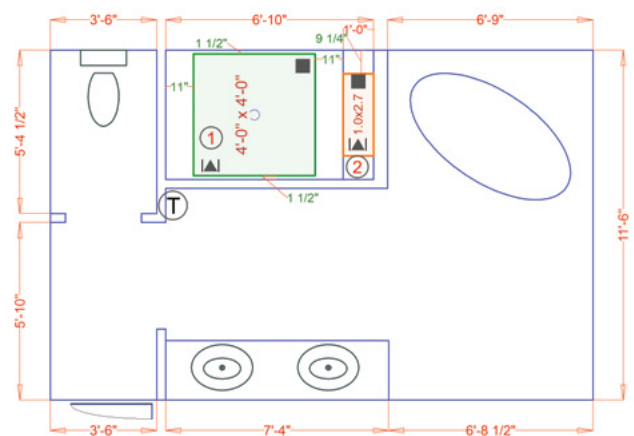

TRT120-4.0x4.0 shown above

The TempZone™ Shower Bench Mats guarantee that the time spent in your shower will be warm and relaxing. The Shower Bench Mats are configured to fit the slim design of shower benches. Each size is smartly designed to cover a standard bench width and length.

TempZone™ Shower Bench Mats						
SKU	WIDTH	LENGTH	SQ. FT.	WATTS	AMPS	MSRP
TRT120-1.0x2.7	11.5"	32"	2.6	39	0.33	\$129
TRT120-1.3x2.7	16.0"	32"	3.6	54	0.45	\$209

TempZone™ Shower Mats have been exclusively designed to provide warmth for two areas in the shower: the floor and shower bench. TempZone™ Shower Floor Mats ensure that the first step into your shower is a warm and soothing experience. The Shower Floor Mats are engineered to cover traditional shower floor areas with allowance for the shower drain. Each Shower Floor Mat is designed with a wire-free drain for fast and easy installation. Now that's smart.

TempZone™ Shower Floor Mats						
SKU	WIDTH	LENGTH	SQ. FT.	WATTS	AMPS	MSRP
TRT120-2.7x2.7	32"	32"	7.1	107	0.89	\$199
TRT120-2.7x5.0	32"	60"	13.3	200	1.67	\$329
TRT120-2.7O5.0	32"	60"	13.3	200	1.67	\$329
TRT120-4.0x4.0	48"	48"	16.0	240	2.00	\$369

Pricing subject to change, because life happens.

TempZone™ Custom Mats

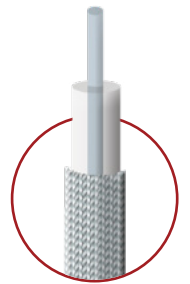

Single Conductor

TempZone™ Custom Mats are designed for use under some of the most commonly heated flooring types like tile and marble. These mats are custom built for each project.

Because they are the exact size and shape needed for the room, they provide the easiest level of installation for floor heating systems. They also provide a superior level of heating coverage for rooms that have non-linear design elements like sharp angles or curves.

TempZone™ Custom Mats are constructed so that the heating element is sandwiched between two layers of fabric which lends a degree of additional durability during the installation process.

For Tile, Marble or Stone

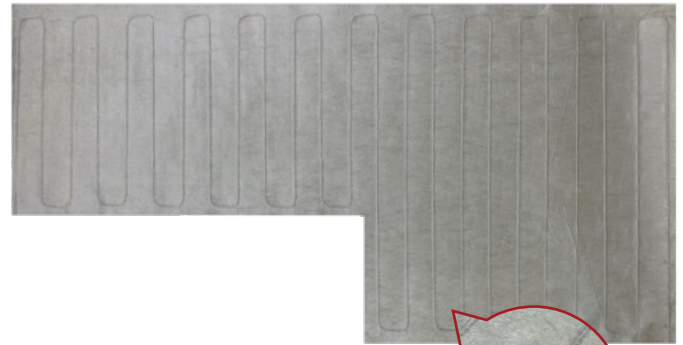

TempZone™ Custom Mat



- Full coverage for any size space, such as bathrooms, kitchens, living rooms or basements
- Easiest installation, no cut and turns required
- Customized, perfect fit for your specific room design
- 12-15 watts per square foot, 1/8" thick
- Circuit Check available to ensure fault-free installation
- ETL Listed

SmartPlan™

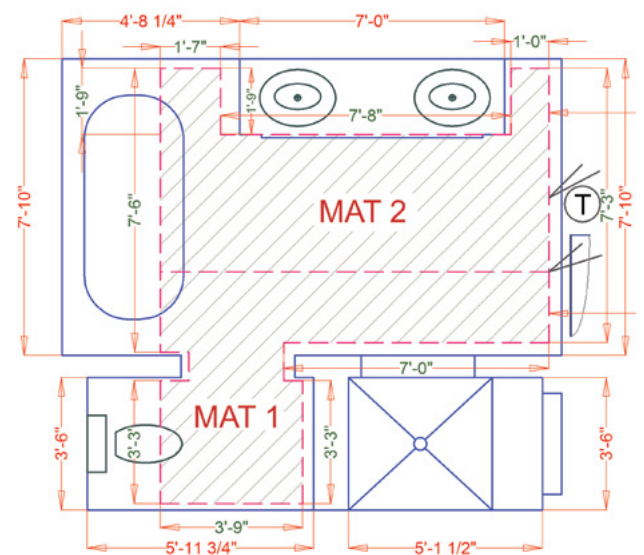

TempZone™

Custom Mats

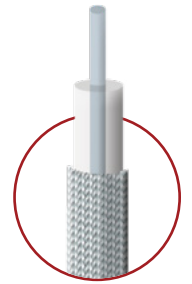

Single Conductor

How To Order

The TempZone™ Custom Mats are tailored to perfectly fit the exact dimensions of your room. Because these are custom, made-to-order mats, they are not available for direct order online. So we thought we'd provide you with a few steps that we recommend to help you purchase and begin enjoying your floor heating as soon as possible.

Step 1

Call a WarmlyYours Sales Representative

The first step is to contact a representative, who will provide expert support throughout the process. Call us today at (800) 875-5285.

Step 2

Accurately Measure the Space

To ensure optimal fit for your custom mat, be sure to have accurate measurements of the room you want to heat. If you have any questions about how to measure a room for floor heating, give our Installation Support team a call at (800) 875-5285.

Step 3

Get an Installation Plan and Free Quote

Once you have completed your measurements and sent them to your WarmlyYours rep, we'll send those measurements to our skilled engineers, who will create a customized installation SmartPlan™ with a free, no obligation quote for your TempZone™ Custom Mat.

Step 4

Place Your Order

After receiving the measurements and SmartPlan™, it's time to place your order. For our custom mats, expect 8 to 10 business days, plus shipping time, for design and production of your mat.

Environ™ Flex Rolls

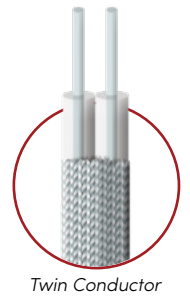

Twin Conductor

WarmlyYours was the first to introduce nonadhesive, foil, electric floor heating to the North American market, and we have over a decade of experience with this advanced design heating technology.

At 12 watts per square foot, the energy-efficient Environ™ systems allow for gradual warming of delicate, floating floor coverings.

The Environ™ Flex Rolls are flexible and specifically designed for easy installation under laminate or floating wood flooring. They can be cut and turned at 90° or 180° to provide thorough wall-to-wall coverage of larger spaces.

For Laminate, and
Floating Hardwood



Environ™ Flex Roll

- Fast and easy installation with cut-and-turn method
- Ultra-thin construction (1/16") won't impact floor height
- Installs without adhesives which means big cost savings
- Provides a heat output of 12-watts per sq. ft.
- 10-year warranty under laminate or floating hardwood
- UL Listed
- Circuit Check available to ensure fault-free installation

SmartPlan™

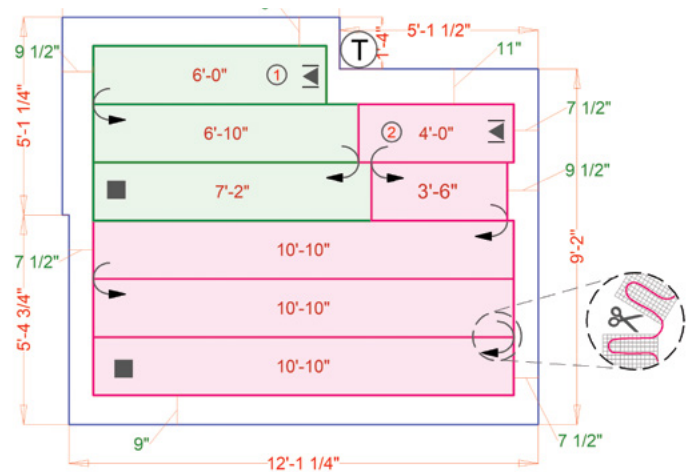

ERT120-1.5X20 and ERT120-1.5X40 shown above

120 Volt Environ™ Flex Rolls

SKU	WIDTH	LENGTH	SQ. FT.	WATTS	AMPS	MSRP
ERT120-1.5x06	1'6"	6'	9.0	108	0.90	\$159
ERT120-1.5x08	1'6"	8'	12.0	144	1.20	\$189
ERT120-1.5x10	1'6"	10'	15.0	180	1.50	\$219
ERT120-1.5x12	1'6"	12'	18.0	216	1.80	\$259
ERT120-1.5x14	1'6"	14'	21.0	252	2.10	\$309
ERT120-1.5x16	1'6"	16'	24.0	288	2.40	\$329
ERT120-1.5x18	1'6"	18'	27.0	324	2.70	\$369
ERT120-1.5x20	1'6"	20'	30.0	360	3.00	\$419
ERT120-1.5x25	1'6"	25'	37.5	450	3.75	\$519
ERT120-1.5x30	1'6"	30'	45.0	540	4.50	\$619
ERT120-1.5x35	1'6"	35'	52.5	630	5.25	\$689
ERT120-1.5x40	1'6"	40'	60.0	720	6.00	\$779
ERT120-1.5x45	1'6"	45'	67.5	810	6.75	\$879

240 Volt Environ™ Flex Rolls

SKU	WIDTH	LENGTH	SQ. FT.	WATTS	AMPS	MSRP
ERT240-1.5x06	1'6"	6'	9.0	108	0.45	\$159
ERT240-1.5x08	1'6"	8'	12.0	144	0.60	\$189
ERT240-1.5x10	1'6"	10'	15.0	180	0.75	\$219
ERT240-1.5x14	1'6"	14'	21.0	252	1.05	\$309
ERT240-1.5x20	1'6"	20'	30.0	360	1.50	\$419
ERT240-1.5x25	1'6"	25'	37.5	450	1.88	\$519
ERT240-1.5x30	1'6"	30'	45.0	540	2.25	\$619
ERT240-1.5x35	1'6"	35'	52.5	630	2.63	\$689
ERT240-1.5x40	1'6"	40'	60.0	720	3.00	\$779
ERT240-1.5x45	1'6"	45'	67.5	810	3.38	\$879
ERT240-1.5x50	1'6"	50'	75.0	900	3.75	\$919
ERT240-1.5x60	1'6"	60'	90.0	1,080	4.50	\$1,109
ERT240-1.5x70	1'6"	70'	105.0	1,260	5.25	\$1,209
ERT240-1.5x80	1'6"	80'	120.0	1,440	6.00	\$1,389
ERT240-1.5x90	1'6"	90'	135.0	1,620	6.75	\$1,559

Pricing subject to change, because life happens.

Environ™ Easy Mats

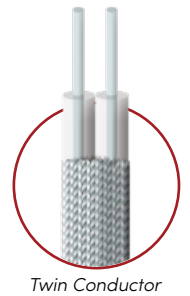

Environ™ Easy Mats can simply be installed “as is”. No cutting or adhesives are required which saves in time and cost. They are available in a wide variety of rectangular sizes.

These are a great option for targeted heating of high traffic areas and are often installed in bedrooms and living rooms.

The wafer thin mat installs directly between an underlayment pad and floor covering to heat the floor and provide even, comfortable warmth. Environ™ Easy Mats are often installed under laminate or floating wood floors.

For Laminate, and
Floating Hardwood



Environ™ Easy Mat

- Great for targeted spot-heating of high traffic areas
- Adhesive-less installation translates to less cost
- Minimal impact on floor height due to thin construction (1/16")
- Heat output of 12-watts per sq. ft.
- 10-year warranty under laminate or floating hardwood
- UL Listed
- Circuit Check available to ensure fault-free installation

SmartPlan™

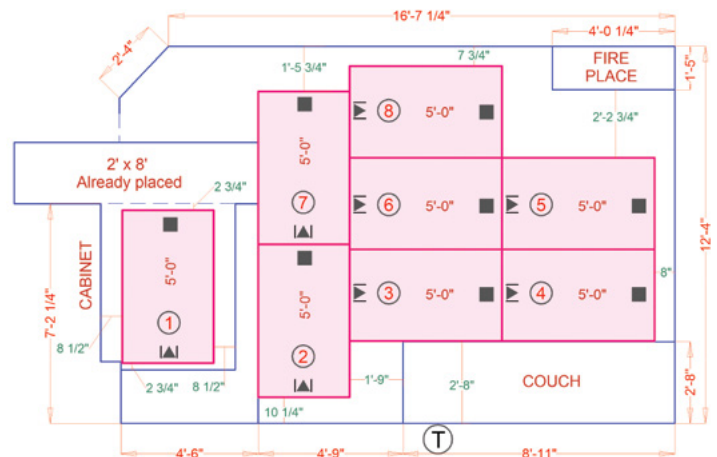

120 Volt Environ™ Easy Mats

SKU	DIMENSIONS	SQ. FT.	WATTS	AMPS	MSRP
ERT120-3.0x05	3' x 5'	15	180	1.50	\$239
ERT120-3.0x08	3' x 8'	24	288	2.40	\$349
ERT120-3.0x10	3' x 10'	30	360	3.00	\$439

Pricing subject to change, because life happens.

120 Volt Slab Heating Mats

SKU	DIMENSIONS	SQ. FT.	WATTS	AMPS	MSRP
WSHM-120-15011	1'6" x 11"	16.5	330	2.75	\$349
WSHM-120-15016	1'6" x 16"	24.0	480	4.00	\$360
WSHM-120-15022	1'6" x 22"	33.0	660	5.50	\$519
WSHM-120-15040	1'6" x 40"	60.0	1200	10.00	\$696
WSHM-120-03021	3' x 21"	63.0	1260	10.50	\$720
WSHM-120-03017	3' x 17"	51.0	1020	8.50	\$739
WSHM-120-15036	1'6" x 36"	54.0	1080	9.00	\$769
WSHM-120-03029	3' x 29"	87.0	1740	14.50	\$912
WSHM-120-03025	3' x 25"	75.0	1500	12.50	\$979
WSHM-120-15056	1'6" x 56"	84.0	1680	14.00	\$1,079

240 Volt Slab Heating Mats

SKU	DIMENSIONS	SQ. FT.	WATTS	AMPS	MSRP
WSHM-240-15064	1'6" x 64"	96.0	1920	8.00	\$1,139
WSHM-240-03040	3' x 40"	120.0	2400	10.00	\$1,369
WSHM-240-15095	1'6" x 95"	142.5	2850	11.88	\$1,519
WSHM-240-03056	3' x 56"	168.0	3360	14.00	\$1,659

Pricing subject to change, because life happens.

Slab Heating Cable

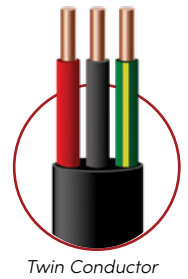

Electric Slab Heating Cables are an economical alternative to our Slab Heating Mats for installing in a new-pour concrete slab for heating basements, garages, or any finished concrete floor.

They can be installed with the cable spaced at different intervals (3", 4", and 5"), which will change the wattage per square foot, depending on your floor warming needs.

Our cable product is priced lower than our mats but it does require more labor. Another benefit of Slab Heating Cables is that they can be used for maximum design flexibility to heat a variety of room shapes and sizes.

- Economical alternative to Slab Heating Mats
- Great for rounded or curved projects
- Delivers between 15 and 20-watts per sq. ft. depending on spacing
- 1/4" thick cables can be embedded in a slab to radiate heat to the surface
- Covered by a 10-year warranty
- cCSAus Listed
- Circuit Check available to ensure fault-free installation

For Polished, Stamped or Stained Concrete

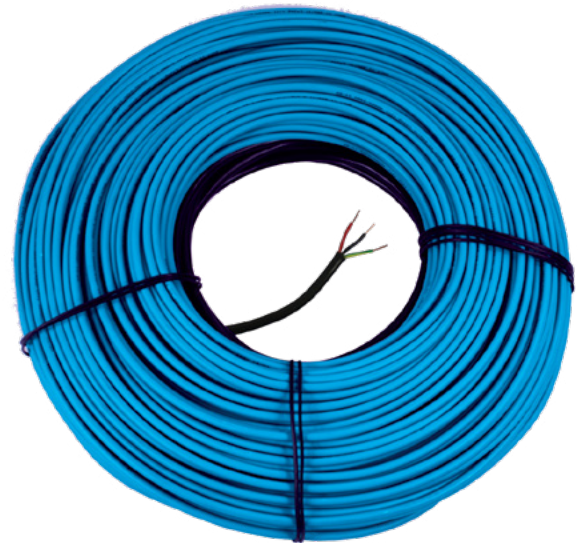

Slab Heating Cable

SmartPlan™

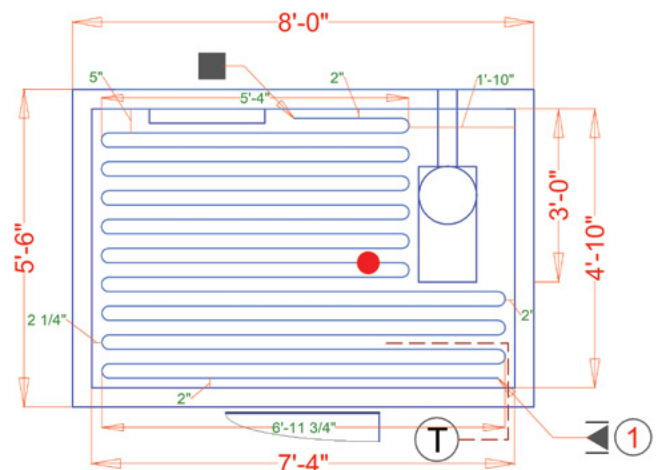

WSHC-120-00112 shown above

The amount of cable you'll need depends on the heat output and amount of heating coverage you want, both of which are impacted by the spacing of the heating cable.

The recommended spacing for Slab Heating Cables is 3", which will provide a heat output of over 20-watts per sq. ft.

You can submit a drawing of your project (with dimensions) and we'll provide you with a free installation plan with the exact amount of cable you'll need.

120 Volt Slab Heating Cables				
SKU	CABLE LENGTH	WATTS	AMPS	MSRP
WSHC-120-00057	57'	330	2.75	\$329
WSHC-120-00082	82'	480	4.00	\$342
WSHC-120-00112	112'	660	5.50	\$499
WSHC-120-00182	182'	1080	9.00	\$618
WSHC-120-00202	202'	1200	10.00	\$702
WSHC-120-00172	172'	1020	8.50	\$719
WSHC-120-00292	292'	1740	14.50	\$852
WSHC-120-00252	252'	1500	12.50	\$959

240 Volt Slab Heating Cables				
SKU	CABLE LENGTH	WATTS	AMPS	MSRP
WSHC-240-00323	323'	1920	8	\$1,079
WSHC-240-00402	402'	2400	10	\$1,159
WSHC-240-00483	483'	2880	12	\$1,499
WSHC-240-00563	563'	3360	14	\$1,569

Pricing subject to change, because life happens.

Floor Heating Controls



UWG4-4999

UWG4-4999-B

nSpire Touch WiFi \$425

This programmable model features touchscreen operation, an easy-to-use Install Wizard, and easy access to a detailed log of its energy use. Its WiFi capability also means that a user can operate their heating system remotely. It can even provide the user with weather reports. Additionally, the nSpire Touch WiFi can be controlled with your voice via a Google Assistant or Amazon Alexa enabled device.

- Available in White or Black
- Can be paired with a Google Assistant or Amazon Alexa enabled device for voice control
- 3.5" color display
- Built-in GFCI safety
- cULus Class A approved
- Dual voltage: 120 V and 240 V
- Max load: 15 Amps
- Includes in-floor sensor
- 3-year warranty



UDG4-4999-WY

UDG4-4999-B

nSpire Touch \$349

Like the nSpire Touch WiFi, this programmable model also features touchscreen operation, an easy-to-use Install Wizard, and easy access to a detailed log of its energy use. In addition to its modern design, the nSpire Touch provides the user with the ability to easily program their radiant heating system to match their needs.

- Available in White or Black
- 3.5" color display
- Built-in GFCI safety
- cULus Class A approved
- Dual voltage: 120 V and 240 V
- Max load: 15 Amps
- Includes in-floor sensor
- 3-year warranty

Floor Heating Controls

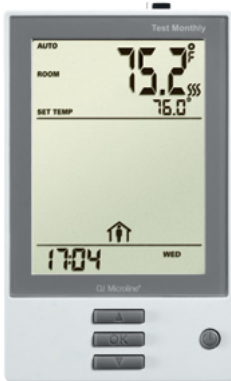

UDG-4999-WY

nHance \$269

This programmable model is button-operated and represents a blend of style and usability. By giving the user control over the programming, this model excels at providing optimal comfort with minimal energy consumption.

- Large back-lit display for easy reading
- Built-in GFCI safety
- cULus Class A approved
- Dual voltage: 120 V and 240 V
- Max load: 15 Amps
- Includes in-floor sensor
- 3-year warranty



UTN4-4999

nTrust \$209

This non-programmable model is button-operated and is perfect for anyone who wants a thermostat that is both easy to install and easy to look at. It's sleek, minimalist appearance blends well with almost any design theme and operating it couldn't be simpler.

- Large back-lit display for easy reading
- Built-in GFCI safety
- cULus Class A approved
- Dual voltage: 120 V and 240 V
- Max load: 15 Amps
- Includes in-floor sensor
- 3-year warranty



USG-4000

nJoin Power Module \$199

Use the nJoin Power Module to link up to a compatible master thermostat to increase electrical output to allow for heating large applications. Simply put, if you need to heat a larger area with one master thermostat, the nJoin Power Module can help.

Radiant Heating Thermostats with Austrian Crystals



Comet Argent Light

This is a full coverage pattern which features a subtle yet alluring design pattern with both black and silver undertones. This pattern pairs particularly well with fixtures that have chrome, polished nickel, or polished stainless steel hardware.



Golden Shadow

This is a full coverage pattern which comes with several different gold shades which creates a breathtaking depth of color and reflection when exposed to light. This pattern pairs particularly well with fixtures that have bronze (oil-rubbed or satin), brass (polished or satin), or copper hardware.



Moonlight

This is a full coverage pattern which has a rich, textured appearance that provides an almost ethereal level of reflectivity when exposed to ambient light. This pattern pairs particularly well with fixtures that have brushed nickel or brushed stainless steel hardware.



Crystal Infinity - White

This pattern features crystals of different sizes in opposing corners set against the thermostat's white faceplate. This pattern pairs particularly well with fixtures that have chrome, nickel (polished or brushed), or stainless steel (polished or brushed) hardware.



Crystal Infinity - Black

This is an opposing corners pattern with different-sized crystals set against the thermostat's black faceplate. This pattern pairs particularly well with fixtures that have matte black or oil-rubbed bronze hardware.

Radiant Heating Thermostats with Austrian Crystals

nSpire Touch Models



UDG4-4999-SC-FB-CA
Comet Argent Light
\$449



UDG4-4999-SC-FB-GS
Golden Shadow
\$449

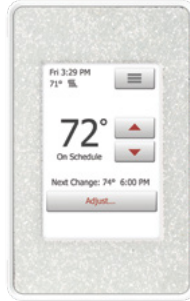

UDG4-4999-SC-FB-ML
Moonlight
\$449

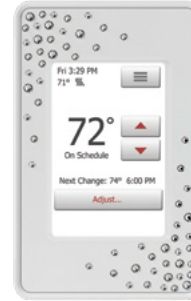

UDG4-4999-SC-MT-CI
Crystal Infinity - White
\$429



UDG4-4999-SC-MT-CI-B
Crystal Infinity - Black
\$429

nSpire Touch WiFi Models



UWG4-4999-SC-FB-CA
Comet Argent Light
\$549

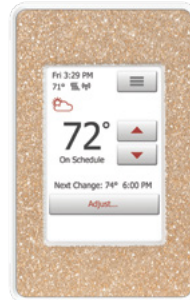

UWG4-4999-SC-FB-GS
Golden Shadow
\$549

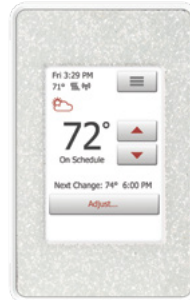

UWG4-4999-SC-FB-ML
Moonlight
\$549

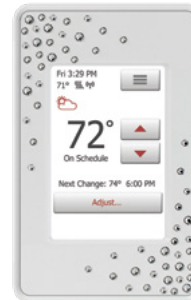

UWG4-4999-SC-MT-CI
Crystal Infinity - White
\$529



UWG4-4999-SC-MT-CI-B
Crystal Infinity - Black
\$529

Prodeso Cable Installation Underlayment

The Prodeso Cable Installation Membrane is an uncoupling membrane that is designed to be used with both TempZone™ Floor Heating Cables and TempZone™ Floor Heating Ruler Cables. The unique design of the membrane allows for greatly accelerated installations of radiant floor heating—in fact, most floor heating installs with this membrane can be completed in a single day.

The polypropylene membrane features integrated channels that are shaped to easily and securely hold the 3.7-watt TempZone™ heating cables. This makes it easy to maintain proper spacing throughout an entire project. The Prodeso membrane also provides uncoupling and crack isolation benefits, which can greatly extend the life of tile, marble, and stone floors.

With the use of ProBand accessories, the membrane can also be waterproofed for high-moisture applications like kitchens or bathrooms. The low 7/32" profile of this membrane means its installation won't significantly increase overall floor height.

- Installed directly over the entire subfloor as an uncoupling, crack isolating membrane
- Limited 10-year warranty



TC-MEM-BL-BND-0624

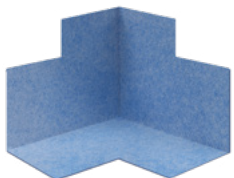

TC-MEM-BL-CNR-IN

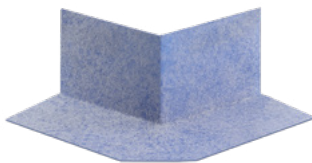

TC-MEM-BL-CNR-OUT

For Tile, Marble or Stone

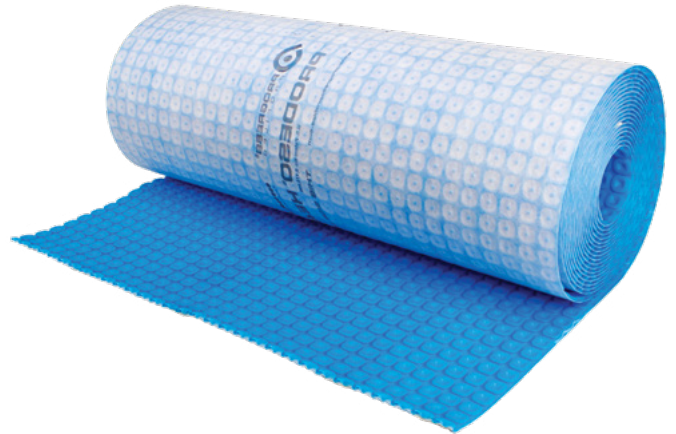

Prodeso Underlayment Membrane

Prodeso Cable Installation Membrane

SKU	SIZE	SQ. FT.	MSRP
TC-MEM-BL-SH39X39	3' 3.4" x 3' 3.4"	10.78	\$75
TC-MEM-BL-054	3' 3.4" x 16' 4.9"	53.87	\$269
TC-MEM-BL-162	3' 3.4" x 49' 2.6"	161.59	\$649

Prodeso ProBand Accessories

SKU	SIZE	MSRP
TC-MEM-BL-BND-0624	6" x 24' Roll	\$109
TC-MEM-BL-CNR-IN	6" x 6"	\$25
TC-MEM-BL-CNR-OUT	6" x 6"	\$25

ThermalSheet

Insulating Underlayment

ThermalSheet is a synthetic cork underlayment that is installed on top of a subfloor and below a heating element. It is recommended when installing an electric floor heating system over a concrete slab to prevent heat loss.

By creating a thermal break, the heat is prevented from sinking into the concrete, and more heat radiates into the floor covering and room. In addition to preventing unnecessary heat loss, ThermalSheet provides sound dampening benefits and double the crack isolation benefits when compared to cork.

ThermalSheet is a synthetic cork underlayment system that is specifically designed for setting tile and stone and is an excellent insulation choice under our TempZone™ and Environ™ electric radiant floor-heating products. ThermalSheet is a very resilient underlayment with compressive strength of 41 psi at 25% strain, 54 psi at 50% strain, and 110 psi at 75% strain.

- Recommended when installing your floor heating system over a concrete slab
- Can be set under tile and stone, over any acceptable sub floor
- Up to 25 times lighter than 1/4" backer board
- Heat and cold resistant, and will not rot, support mold and mildew, or absorb moisture
- Stable and durable, remaining unchanged after repeated impact loads
- Limited 5-year warranty

For Tile, Marble or Stone

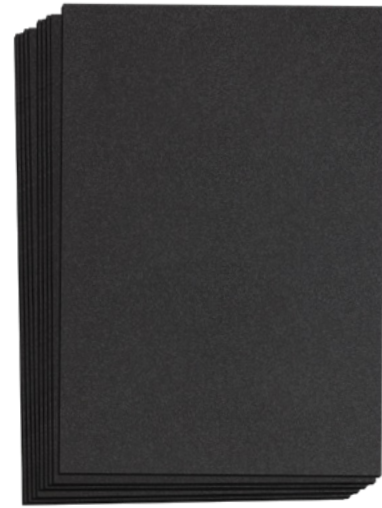

ThermalSheet Insulating Underlayment

ThermalSheet Insulating Underlayment

SKU	SIZE	SQ. FT.	MSRP
TS-SH6MM-24x36	One 2' x 3' Sheet	6	\$32

Accessories

Electrical Rough-In Kits

Whether you're a homeowner or trade professional, it's vital to have the right tools for your radiant heating project. To provide this peace of mind, WarmlyYours has developed our Electrical Rough-In Kits that cover any local electrical code. These kits include everything you need to safely and correctly install a thermostat.

Our kits are available with either single-gang or double-gang boxes.



FHE-ROUGH-IN-KIT-S3

Electrical Rough-in Kit with 2 Conduits

\$99

This is a great option for areas where the local code requires a separate conduit for low-voltage wires. With everything an electrician will need to install and connect a thermostat in accordance with this type of electrical code, this kit has you covered.

Included Items

- 3" X 2" X 3 1/2" Single-Gang Box
- 5" Cable Protector
- (2) 1/2" x 6' Flexible Metal Conduit
- (4) 1/2" Flexible Metal Conduit Anti-short Bushing
- (2) 1/2" Set Screw Connector
- (2) 1/2" EMT Drive Strap
- 3/8" x 4" Black Flex Tube



FHE-ROUGH-IN-KIT-S2

Electrical Rough-in Kit with Conduit

\$79

Getting the job done correctly has never been easier with this complete electrical kit. It contains everything an electrician needs to install and connect a thermostat with an electric radiant heating system in accordance with National Electric Code.

Included Items

- 3" X 2" X 3 1/2" Single-Gang Box
- (25) 3/16" or 5mm low-volt staples
- 5" Cable Protector
- 1/2" x 6' Flexible Metal Conduit
- 1/2" Flexible Metal Conduit Anti-short Bushing
- 1/2" Set Screw Connector
- 1/2" EMT Drive Strap
- 3/8" x 4" Black Flex Tube



FHE-ROUGH-IN-KIT-S1

Electrical Rough-in Kit without Conduit

\$49

This kit was developed for projects in which the local electrical code does not require conduit for the low-voltage sensor wire or the power leads. It includes everything an electrician will need for installing and connecting a thermostat.

Included Items

- 3" x 2" x 3 1/2" Single-Gang Box
- (25) 3/16" or 5mm low-volt staples
- 5" Cable Protector
- 3/8" x 4" Black Flex Tube

Merchandising Materials

WarmlyYours offers merchandising materials for our radiant heating products. We've featured some of our most popular items in this section. See our entire line of merchandising materials online at www.WarmlyYours.com.



Showroom In-floor Display Package

- The first 15 sq. ft. of floor heating of your choice is FREE (any additional square footage is available at 50% off)
- For under tile or stone flooring, choose from TempZone™ Flex Rolls, Easy Mats, Cables
- For under laminate, or floating wood flooring, choose from Environ™ Flex Rolls or Easy Mats
- Includes a programmable thermostat and Circuit Check
- Includes ThermalSheet underlayment



Heated Tabletop Display

12" W x 16" H x 10 1/2" D heated tabletop display plugs into 120V outlet, with two take-one cups



Take-One Brochure

8" x 4" tri-fold take-one brochures



Sample Cards

Product sample cards with dealer imprint area on back. (4.5" x 4.5")

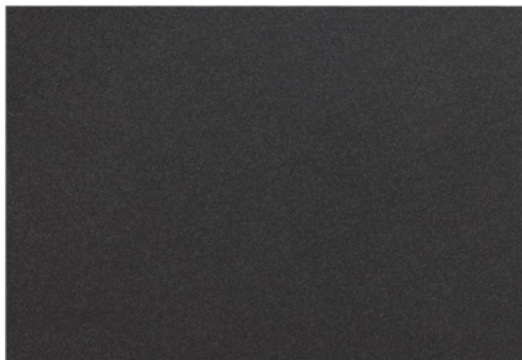

Underlayment Sample

Our ThermalSheet insulating underlayment increases energy efficiency and will not rot, absorb moisture, or support mold or mildew

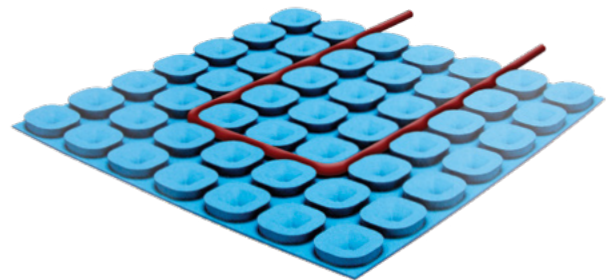



TempZone™ Floor Heating Cable & Prodeso Sample

Product sample (5" x 6", 1 sample)



Be Connected.
Be Warm. Be Radiant.

WarmlyYours HQ 
590 Telser Road,
Lake Zurich, IL 60047

WarmlyYours 
300 Granton Drive, Unit 4A
Richmond Hill, ON L4B1H7

WarmlyYours 
Blaak 520 3011 TA
Rotterdam, Netherlands

800-875-5285
www.WarmlyYours.com

Connect with Us



Industry leading 24/7 installation and technical support.
Our experts can answer any technical questions on
any product we offer, 24/7.



Scan here to learn
more about Electric
Floor Heating.

Ask us about our
Outdoor Heating, Towel Warmer
and Radiant Heating Panel Catalogs

Pricing subject to change without notification.